

Reconfigurable Bandpass Filter Structure using an SPDT MEMS Switch

Carlos E. Saavedra

Queen's University, Department of Electrical and Computer Engineering
Kingston, ON K7L 3N6, Canada
Carlos.Saavedra@queensu.ca

Abstract — A concept for a bandpass reconfigurable filter structure capable of operating a two different passbands is presented. The circuit consists of two edge-coupled-line bandpass filters and a single-pole double throw MEMS switch. The incident signal enters a three-conductor set of coupled lines which feeds the two bandpass filters. The switch selects between the outputs of the two filters and thus a reconfigurable system is obtained. The switch used uses a magnetic actuation system and requires a voltage pulse of less than 4.0 V and consumes a peak transient current of 49 mA. The quiescent current consumption is 0 mA. The two passbands of the system presented here are at 1.8 GHz and 2.2 GHz. The rejection between the bands is about 20 dB. Much better rejection is possible by improving the isolation characteristic of the switch.

I. INTRODUCTION

CURRENTLY, many microwave transmitter and receiver systems are useful only at one frequency band because the microstrip bandpass filters used for channel selection are not easily reconfigurable or even tunable. This is one of the reasons why it is often necessary to design multiple transmit-receive units for similar communications systems operating at different bands. As a result, the cost of microwave communications links is sometimes high and can limit market access.

With the arrival of RF MEMS technology in the last decade, there has been a significant amount of activity in trying to develop a wide variety of components that can be reconfigurable and/or electronically tunable in order to allow for transceiver re-use at different frequency bands. Examples of such components include antennas, phase shifters, and filters.

In the area of filter design, most of the work to date has been devoted to creating frequency-tunable circuits [1,2]. In these filters, the passband of the filter changes with an applied DC voltage. Although the tunable filters hold significant promise because the center frequency can be continuously changed over a certain range of frequencies, these circuits typically require large actuation voltages on the order of tens to even hundreds of volts. Thus, their integration with low-voltage (< 5V) integrated circuits remains a challenge.

MEMS devices have also been used to implement reconfigurable filters in which the physical structure of the filter can be changed. In [3], a coplanar

waveguide low-pass filter was physically reconfigured to change the cutoff frequency of the filter over a wide range. For bandpass filters, the passband can be changed from one center frequency to another in discrete or continuous amounts [4]. The main distinguishing characteristic between reconfigurable and tunable bandpass filters from a functionality point-of-view is that the center frequency and bandwidth of the filter can be changed simultaneously in a reconfigurable filter albeit in discrete steps. In most tunable filters, on the other hand, it is typically only the center frequency that can be changed.

In this paper, a type of reconfigurable edge-coupled line microstrip bandpass filter is presented. The system has a single input and then splits into two bandpass filters that are independently designed to have a specified center frequency and passband. A magnetically actuated single-pole double-throw (SPDT) MEMS switch is used to select between one of the two bandpass filters. The switch used in this work requires an actuation voltage of less than ± 4 V and has zero quiescent power dissipation, which makes it very attractive for integration with electronic control circuitry. The concept presented here can be used to transform certain diplexer designs [5,6] into reconfigurable filters.

This paper is organized as follows: in Section II the filter operation and design are described, in Section III the MEMS switch is discussed, Section IV contains experimental results, and Section V concludes the work.

II. FILTER DESCRIPTION AND DESIGN

The objective of this work was to design a bandpass filter with a selectable center frequency and bandwidth. To that end, the structure in Figure 1 was created.

Since the circuit in Figure 1 consists of two filters in parallel, the first task was to devise method to split the input signal into two paths. One alternative could be to use a power splitter such as branchline coupler or a ring-hybrid circuit, but these take space and there is an effective 3 dB power loss. To avoid these problems, a three-conductor coupled line system was used in this work to effectively split the signal into two paths.

The input signal enters the three-conductor set of coupled lines through the center transmission line.

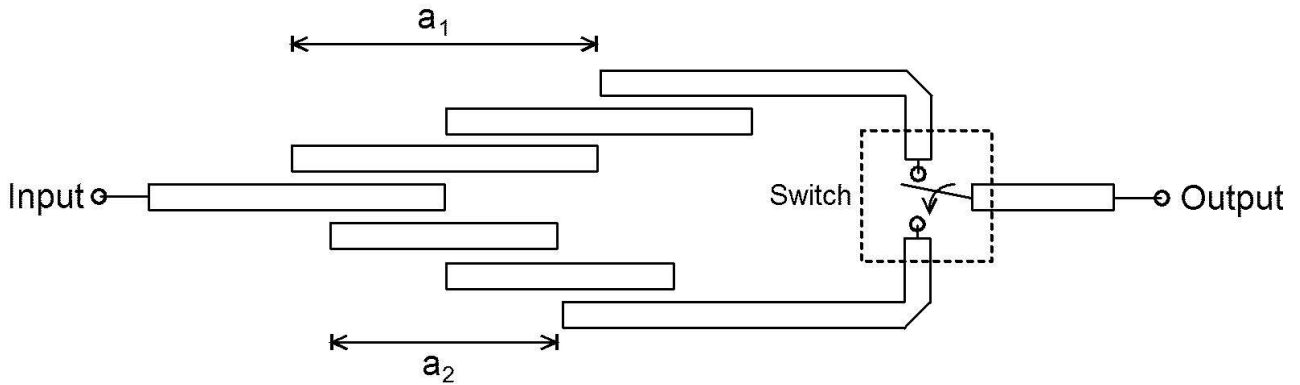

Figure 1 Reconfigurable filter using a MEMS switch

Energy is coupled from the center conductor to either the top or bottom microstrip transmission edge-coupled resonators depending on the frequency of the signal. An SPDT MEMS switch is used to select between the top or bottom filter structures and thus center-frequency selection is achieved. The MEMS switch used in this work is a packaged, commercially available, magnetically actuated device [7].

The two edge-coupled microstrip bandpass filter structures can be designed independently of each other for the case that their 3-dB passbands do not overlap, which is the most common situation. If the passbands were to overlap, a significant amount of energy would be coupled simultaneously to the top and bottom filters and the frequency response would show a higher insertion loss for each individual filter. In addition, a notch will appear in each filter's passband corresponding to the center-frequency of the opposite filter due to maximum energy coupling at that frequency.

The bandpass filters in Figure 1 can be easily simulated using any CAD package that contains a three-conductor coupled-line model. In order to account for the fact that the top and bottom coupled lines in the three-conductor structure have different lengths, the problem can be split into three simpler structures, as shown in Figure 2. This simplification allows one to quickly simulate the filter structure using a circuit-level simulator instead of having to perform a full-wave analysis using an electromagnetic field solver. The left-hand side of Figure 2 shows the input transmission line and half of the top ($a_1/2$) and bottom ($a_2/2$) coupled lines. The circuit on the right in Figure 2 shows a three-conductor coupled line section with a length of $a_2/2$. This three-conductor section is preceded by a two-conductor coupled line having a length of,

$$b = \frac{1}{2}(a_1 - a_2).$$

The two-conductor coupled line is itself preceded by a simple length of transmission line, which is the input to the system. As will be seen in Section IV, this approximation to the three-conductor coupled line problem predicted the filter performance very well.

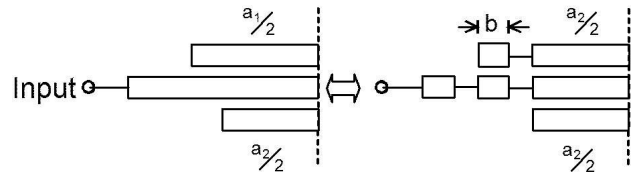

Figure 2 Equivalent circuit for three-conductor coupled line system with different top and bottom transmission line lengths.

III. MEMS SWITCH

The MEMS switch used in this work was a packaged single position double throw (SPDT) device that operated using the principle of magnetic actuation [7,8]. In this particular device, a permanent magnet is used as the base, on top of which is a silicon substrate, where the surface micromachining steps are performed. A metallic coil is patterned atop the silicon surface through which current pulses are passed in order to change the magnetization of a cantilever beam made of a soft magnetic material (permalloy) such as NiFe. The cantilever is supported in air by two torsion flexures. The torque exerted by the permanent magnet on the beam will cause the cantilever to close the gap between a pair of transmission lines. When a current pulse is sent through the coil, the magnetization of the beam will switch, and this will create a torque in the opposite direction. The result is that the gap between the two transmission lines will be open.

Since the switch works by changing the magnetization of the cantilever beam, once the device is actuated, it requires zero quiescent current to maintain it in either of its bistable states. In this work, the actual voltages used were +3.56 V and -3.86 V.

IV. EXPERIMENTAL RESULTS

The reconfigurable filter in Figure 1 was fabricated on a microwave substrate with a relative dielectric constant of 3.15 and a thickness of 0.5 mm. The top bandpass filter was designed to have a center frequency of 1.8 GHz by using a resonant length, a_1 , of 26.6 mm and the bottom bandpass filter had a center frequency of 2.2 GHz using

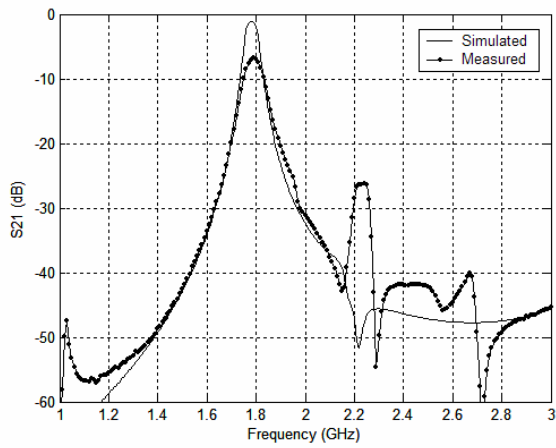

(a)

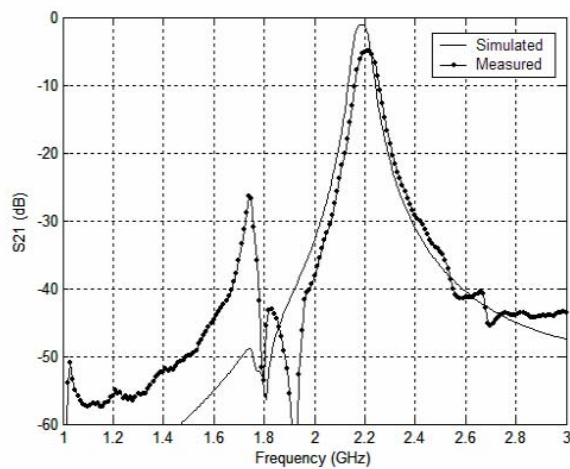

(b)

Figure 3 – Experimental and simulated results for the reconfigurable filter (a) top filter position (b) bottom filter position after SPDT switch actuation.

$a_2 = 21.7$ mm. Both filters had a 3-dB bandwidth of 60 MHz. For the top filter, the gap of the first and third coupled lines was 0.28 mm and for the middle coupled lines it was 1.56 mm. For the bottom filter, the gap of the first and third coupled lines was 0.30 mm, and the gap of the center coupled lines was 1.64 mm. For both filters, the transmission line widths were 1.1 mm.

Figure 3a shows the simulated (ADS) and experimental results when the SPDT switch was in the top position, thus connecting the top filter to the output. When a voltage pulse of -3.86 V was applied to the control pad of the switch, the device changed states and the bottom filter was connected to the output. This situation is plotted in Figure 3b. The maximum DC current draw during the pulse transient was 49 mA. After the pulse is applied to the switch, the control voltage can return to 0 V and the switch will remain in its current position, thereby consuming zero standby power. To revert the switch back to the top position, a pulse of 3.56 V is applied. The low actuation voltage required to change between the two

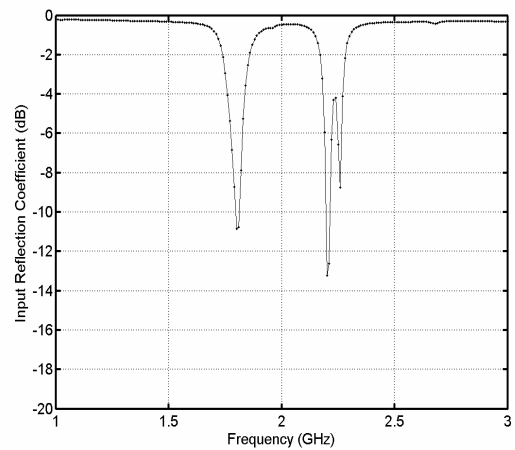

(a)

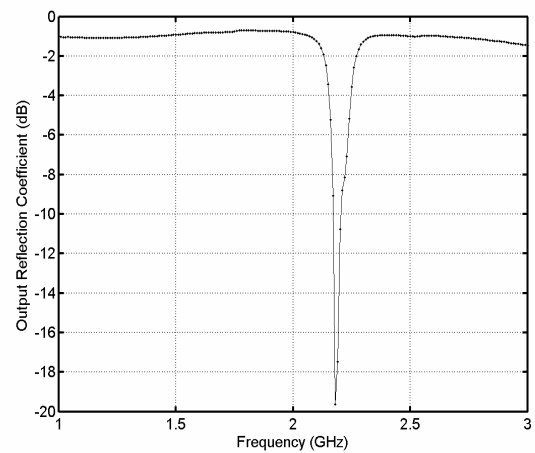

(b)

Figure 4 – Experimental results : (a) input reflection coefficient and (b) output reflection coefficient for one actuation state.

states of the switch makes this an attractive solution for integration with MMIC's.

From the graph in Figure 3a, it is observed that there is a certain amount of unwanted energy feedthrough at 2.2 GHz. Similarly, the graph in Figure 3b shows feedthrough at 1.8 GHz. The rejection between the passband and the feedthrough signal is 19.4 dB in the top graph and 21.3 dB in the bottom graph in Figure 3. These rejection values can be greatly improved by using a MEMS switch with a better isolation.

In Figure 4 the measured input and output reflection coefficients are plotted for this circuit. It is seen in Figure 4a, that the input reflection coefficient has two notches, which correspond to the passbands of the top and bottom filters. This can be explained by realizing that energy is coupled into to top and bottom filters by the three coupled-line structure. It is only at the switch location that it is determined which of the two filters is connected to the output. The data in Figure 4b was taken when the switch was in the bottom position (see Figure 1) so that the filter with the 2.2 GHz center frequency was

connected to the output. A photograph of the fabricated circuit is shown in Figure 5.

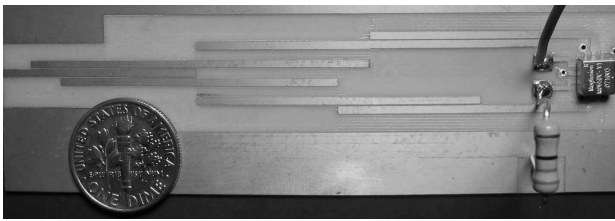

Figure 5 Photograph of fabricated filter structure

V. CONCLUSION

In this work, a concept for a reconfigurable bandpass filter structure is presented. The circuit consists of two microstrip edge-coupled line bandpass with a common input transmission line using a three-conductor coupled line system. An SPDT MEMS switch is used to select between the two filters. This circuit can be used in a variety of transceiver applications that require channel selection.

REFERENCES

- [1] H.-T. Kim, J.-H. Park, Y.-K. Kim, Y. Kwon, "Low-Loss and Compact V-Band MEMS-Based Analog Tunable Bandpass Filters," *IEEE Microwave and Wireless Components Lett.*, Vol. 12, No. 11, Nov. 2002, pp. 432-434.
- [2] C. D. Nordquist, et. al., "An X-Band to Ku-Band RF MEMS Switched Coplanar Strip Filter," *IEEE Microwave and Wireless Components Lett.*, Vol. 14, No. 9, Sept. 2004, pp. 425-427.
- [3] S. Lee, J.-H. Park, J.-M. Kim, H.-T. Kim, Y.-K. Kim, Y. Kwon, "A Compact Low-Loss Reconfigurable Monolithic Low-Pass Filter Using Multiple-Contact MEMS Switches," *IEEE Microwave and Wireless Components Lett.*, Vol. 14, No. 1, Jan. 2004, pp. 37-39.
- [4] D. Peroulis, S. Pacheco, K. Sarabandi, L. P. B. Katehi, "Tunable Lumped Components with Applications to Reconfigurable MEMS Filters," *IEEE MTT-S Digest*, Phoenix, AZ, 2001, pp. 341-344.
- [5] D. Rubin, D. Saul, "Millimeter Wave MIC Bandpass Filters and Multiplexers," *IEEE MTT-S Digest*, Vol. Jun. 1978, pp. 208-210.
- [6] A. R. Brown, G. Rebeiz, "A High-Performance Integrated K-Band Diplexer," *IEEE Trans. Microwave Theory and Tech.*, Vol. 47, No. 8, Aug. 1999, pp. 1477-1481.
- [7] *MagLatch ML06 datasheet*, Magfusion Inc., Chandler, AZ, 2004. Available: <http://www.magfusion.com>.
- [8] M. Ruan, J. Shen, C. B. Wheeler, "Latching Micromagnetic Relays," *IEEE J. Microelectromechanical Systems*, Vol. 10, No. 4, pp. 511-517, Dec. 2001.